

DISPLAY PRESSURE SWITCH

Swiss based Trafag is a leading international supplier of high quality sensors and monitoring instruments for measurement of pressure and temperature. The DPC 8380 is the ideal combination of pressure switch and transmitter with pressure display. The parameters are set on the device or in a timesaving way via an NFC - smartphone App. The settings in combination with a comprehensive set of options make the DPC 8380 suitable for a wide range of industrial applications.



Applications

- Machine tools
- HVAC
- Refrigeration
- Water treatment
- Process technology

Features

- Parametrisation also via NFC-smartphone App (Android)
- Display and electrical connection are independently rotatable 335°/343°
- Analogue output switchable mA or V
- Integrated datalogger
- Pressure range adjustable, 50 ... 100 % of the nominal range

04/2017

Data sheet H72320e

Technical Data			
Measuring principle	Thick film on ceramic	Media temperature	-25°C ... +85°C
Measuring range	0 ... 1 to 0 ... 100 bar 0 ... 15 to 0 ... 1500 psi adjustable 50 ... 100 % FS	Ambient temperature	-25°C ... +85°C
Output signal	4 ... 20 mA, 0 ... 5 VDC, 1 ... 6 VDC, 0 ... 10 VDC, switchable mA or V	Pressure unit for display	bar, psi, MPa, kPa, m WC, mm WC
Switching output	2 transistors PNP	Logger	Ring buffer: 3518 data points Sampling time: 0.1 ... 999.9 s, Off (0)
Accuracy @ 25°C typ.	± 0.5 % FS typ.		

Subject to change

Ordering information/type code

				8380 . XX			XX	XX	XX	XX	XX
Measuring range ¹⁾	Pressure measurement range [bar]	Over pressure [bar]	Burst pressure [bar]		Pressure measurement range [psi]	Over pressure [psi]	Burst pressure [psi]				
	0 ... 1	2	4.8	71	0 ... 15	45	70	G1			
	0 ... 1.6	3.2	4.8	73	0 ... 20	45	70	G3			
	0 ... 2.5	5	7.5	75	0 ... 30	60	90	G5			
	0 ... 4	8	12	76	0 ... 50	100	150	G6			
	0 ... 6	12	15	77	0 ... 100	200	250	G7			
	0 ... 10	20	25	78	0 ... 150	300	375	G8			
	0 ... 16	32	40	79	0 ... 250	500	625	G9			
	0 ... 25	50	75	80	0 ... 400	800	1200	H0			
	0 ... 40	80	100	81	0 ... 500	1000	1250	H1			
	0 ... 60	120	180	82	0 ... 1000	2000	3000	H2			
	0 ... 100	200	300	83	0 ... 1500	3000	4500	H3			
	Sensor	Relative pressure, 1.4305, accuracy: 0.5 %			57	Absolute pressure, 1.4305, accuracy: 0.5 % ³⁾			87		
Relative pressure, 1.4404/1.4435, accuracy: 0.5 % ⁴⁾			59	Absolute pressure, 1.4404/1.4435, accuracy: 0.5 % ^{3) 4)}			89				
Relative pressure, 1.4462, accuracy: 0.5 % ⁴⁾			52	Absolute pressure, 1.4462, accuracy: 0.5 % ^{3) 4)}			82				
Relative pressure, Titanium Grade 5, accuracy: 0.5 % ⁴⁾			53	Absolute pressure, Titanium Grade 5, accuracy: 0.5 % ^{3) 4)}			83				
Pressure connection	G1/4" female		10	R1/4" male DIN3858 ⁴⁾			19				
	G1/4" male		17	7/16"-20UNF male, DIN3866 ⁴⁾			18				
	G1/2" male DIN3852-E ⁴⁾		41	7/16"-20UNF female SAE J512 with valve opener ⁴⁾			24				
	1/4" NPT male ⁴⁾		30	7/16"-20UNF female SAE4 ⁴⁾			42				
Electrical connection	Male electrical plug M12x1, 4-pole, Mat. PA (Accessories P3, P4)							32			
	Male electrical plug M12x1, 5-pole, Mat. PA (Accessories P1, P2)							35			
Output signal	Switching output PNP, current output 4 ... 20 mA; output detail see accessories P1, P2, P3									PA	
	Switching output PNP, voltage output 1 ... 6 VDC; output detail see accessories P1, P2, P3									PU	
	Switching output PNP, voltage output 0 ... 10 VDC; output detail see accessories P1, P2, P3									PV	
	Switching output PNP, voltage output 0 ... 5 VDC; output detail see accessories P1, P2, P3									PW	
	Switching output PNP; output detail see accessory P4									PS	
Accessories	Pin configuration 5-pole.; 1: U+, 2: analogue, 3: U-, 4: SP1, 5: SP2									P1	
	Pin configuration 5-pole.; 1: U+, 2: SP2, 3: U-, 4: SP1, 5: analogue									P2	
	Pin configuration 4-pole.; 1: U+, 2: analogue, 3: U-, 4: SP1									P3	
	Pin configuration 4-pole.; 1: U+, 2: SP2, 3: U-, 4: SP1									P4	
	Pressure peak damping element ø 1.0 mm (for pressure connections 17 and 30)									40	
	Pressure peak damping element ø 0.4 mm (for pressure connections 17 and 30)									44	
	Seal FPM, -18°C ... +125°C									61	
	Seal EPDM, -40°C ... +125°C									63	
	Female electrical plug M12x1, 5-pole ⁵⁾									33	
	Parametrisation standard (see table Parameter)									ZS	
	Parametrisation according to customer specifications (see table Parameter)									ZC	

¹⁾ Extended overpressure as well as customized pressure ranges upon request

³⁾ Absolute ranges max. 40 bar

⁴⁾ Please ask us

⁵⁾ For electrical connections 32 and 35

Parameter				
Name	Standard adjustment (Accessory ZS)	Value range	Shortname	Customer adjustment (Accessory ZC)
Switch point SP1 (hysteresis mode) Upper switch point FH1 (window mode)	75 % Measuring range	SP1 > RP1 FH1 > FL1 Hysteresis ≥ 1 % d.S.	SP1	
Reset point RP1 (hysteresis mode) Lower switch point FL1 (window mode)	25 % Measuring range	RP1 < SP1 FL1 < FH1 Hysteresis ≥ 1 % d.S.	RP1	
Switch point SP2 (hysteresis mode) Upper switch point FH2 (window mode)	75 % Measuring range	SP2 > RP2 FH2 > FL2 Hysteresis ≥ 1 % d.S.	SP2	
Reset point RP2 (hysteresis mode) Lower switch point FL2 (window mode)	25 % Measuring range	RP2 < SP2 FL2 < FH2 Hysteresis ≥ 1 % d.S.	RP2	
Switch point delay time SP1 (hysteresis mode) Switch point delay time FH1 (window mode)	0	0 ... 99.99 s	dS1	
Switch point delay time RP1 (hysteresis mode) Switch point delay time FL1 (window mode)	0	0 ... 99.99 s	dR1	
Switch point delay time SP2 (hysteresis mode) Switch point delay time FH2 (window mode)	0	0 ... 99.99 s	dS2	
Switch point delay time RP2 (hysteresis mode) Switch point delay time FL2 (window mode)	0	0 ... 99.99 s	dR2	
Function switching output 1	Hysteresis, closer (Hno)	Hysteresis NO (Hno), Hysteresis NC (Hnc) Window NO (Fno), Window NC (Fnc)	ou1	
Function switching output 2	Hysteresis, closer (Hno)	Hysteresis NO (Hno), Hysteresis NC (Hnc) Window NO (Fno), Window NC (Fnc)	ou2	
Pressure unit	bar	bar, psi, MPa, kPa, m WC	uni	
Measuring range adjustment	100 % Nominal pressure	50 ... 100 % Nominal	P-EP	
Damping analogue output	0.01 s	0.01 ... 3.00 s (time constant)	dAA	
Display rotation	No	No, yes (180°)	disr	
Display mode	Current pressure value	Pressure value: current, highest, lowest, display off Current value: decimal places selectable (max. 3)	dis	
Display actualisation	2	1, 2, 5, 20 Hz	duPd	

Specifications		
Electrical Data	Output / supply voltage	4 ... 20 mA: 24 (15 ... 30) VDC 0 ... 5 VDC: 24 (15 ... 30) VDC 1 ... 6 VDC: 24 (15 ... 30) VDC 0 ... 10 VDC: 24 (15 ... 30) VDC
	Switch-on-delay	Typ. 200 ms
	Inverse-polarity protection, short-circuit strength @ 25°C during 5 min.	integrated
	Current consumption	≤ 30 mA
Environmental conditions	Media temperature	-25°C ... +85°C
	Ambient temperature	-25°C ... +85°C
	Protection ¹⁾	IP65
	Humidity	Max. 95 % relative
	Vibration	10 g (10 ... 2000 Hz)
	Shock	50 g / 3 ms
EMC Protection	Emission	EN/IEC 61000-6-3
	Immunity	EN/IEC 61000-6-2
Mechanical Data	Sensor (wetted parts)	Ceramic, Al ₂ O ₃ (96 %)
	Pressure connection (wetted parts)	57/87: 1.4305 (AISI303) 59/89: 1.4404/1.4435 (AISI316L) 52/82: 1.4462 (AISI318LN) 53/83: Titanium Grade 5
	Housing	Steel, die cast metal galvanised display housing plastic
	Sealing	FPM, EPDM
	Male electrical plug	See ordering information
	Weight	~ 189 g
	Mounting torque	15 ... 20 Nm
	Housing alignment	Display 335° rotatable, max. 2.5 Nm Electrical connection 343° rotatable, max. 5 Nm

¹⁾ See electrical connection

Measuring accuracy 0.5 %

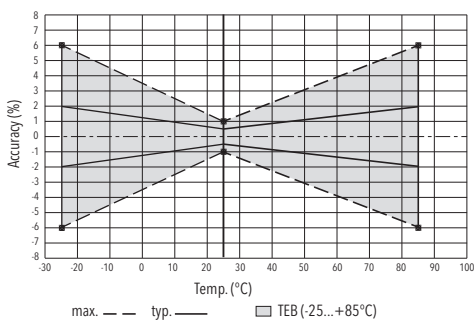

Analogue output			
Output signal	Reversible 4 ... 20 mA or voltage		
Accuracy	TEB @ -25...+85°C	[% FS typ.]	± 2.0
	Accuracy @ +25°C	[% FS typ.]	± 0.5
	NLH @ +25°C (BSL)	[% FS typ.]	± 0.2
	TC zero point and span	[% FS/K typ.]	± 0.03
Current limiting output signal	Long term stability 1 year	[% FS typ.]	± 0.3
	4 ... 20 mA: 25 mA (overload)		
Damping (rise time)	0 ... 10 VDC: < 40 mA (short-circuit)		
	0.01 ... 3.00 s / 10 ... 90 % Nominal pressure		

Switching output			
Accuracy	Accuracy @ +25°C	[% FS typ.]	± 0.5
	TEB @ -25...+85°C	[% FS typ.]	± 2.0
	Long term stability 1 year	[% FS typ.]	≤ ± 0.3
Adjustment range of switchpoints	0 ... 100 % FS		
Switching hysteresis	≥ 1 % FS		
	Switchpoint > reset point		
Switching resistance	≤ 3 Ω		
Output function	Hysteresis, Window; normally closed (NO), normally open (NC)		
Switching current	≤ 0.5 A each switching output		
Current limiting	≤ 2 A each switching output		
Switching frequency	max. 200 Hz		
Delay time	0 ... 99.99 s		

Display	
Display	4-digit 7-segment display 180° flippable with disable function Standard decimal places: ≤ 9: 3 decimal places 10 ... 99: 2 decimal places 100 ... 999: 1 decimal place
Switching status indication	2 LED, red
Operation	With 3 buttons and menu navigation according to VDMA 24574-1
Display resolution	0.1 % FS
Display range	-3 ... 103 % FS
Setting parameters	Refer to table parameter

Dimensions

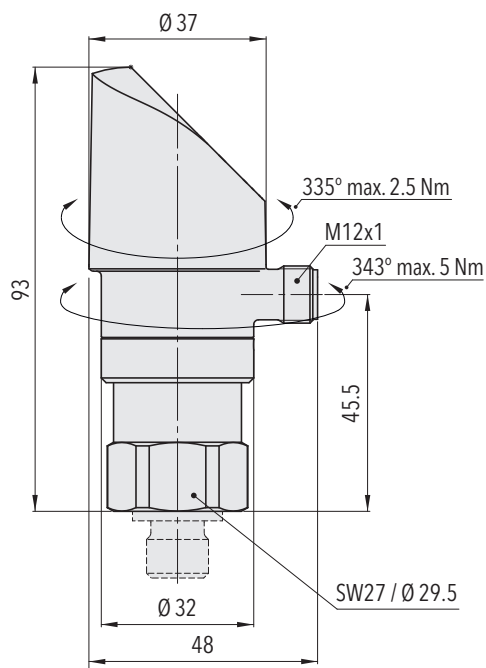

8380.XX.XXXX.35/32.XX.XX

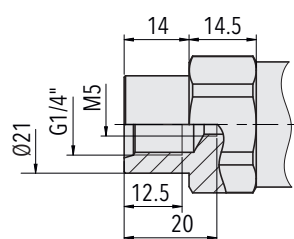

8380.XX.XX10.XX.XX.XX

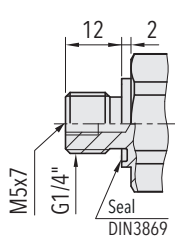

8380.XX.XX17.XX.XX.XX

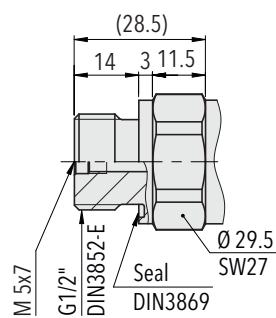

8380.XX.XX41.XX.XX.XX

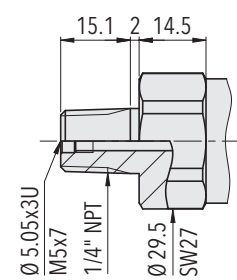

8380.XX.XX30.XX.XX.XX

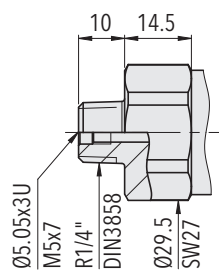

8380.XX.XX19.XX.XX.XX

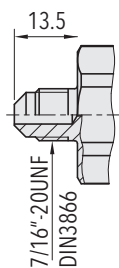

8380.XX.XX18.XX.XX.XX

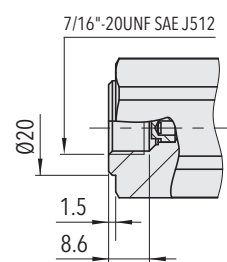

8380.XX.XX24.XX.XX.XX

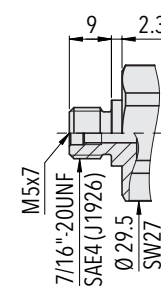

8380.XX.XX42.XX.XX.XX

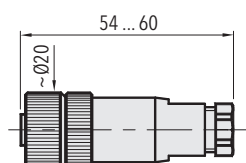

8380.XX.XXXX.XX.XX.33

Electrical connection

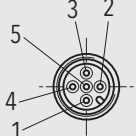
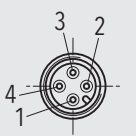
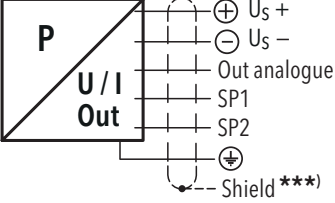
		Protection / electrical connection			
		IP65*)			
		M12x1			
		5-pole 35		4-pole 32	
					
Output signal		P1	P2	P3	P4
	PA	✓	✓	✓	
	PU	✓	✓	✓	
	PV	✓	✓	✓	
	PW	✓	✓	✓	
	PS				✓
Pin Configuration		P1	P2	P3	P4
	8380.XX.XXXX.XX.PA/PU/PV/PW/PS	1 3 2 4 5 Shield (***)	1 3 5 4 2 Shield (***)	1 3 2 4 Shield (***)	1 3 - 4 2

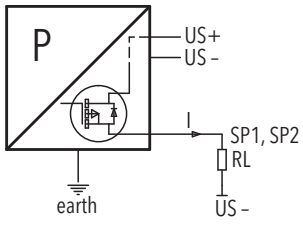

Connection of loads to switching output

*) Provided female connector is mounted according to instructions
 ***) The use of a shielded cable is recommended

Functions switching output

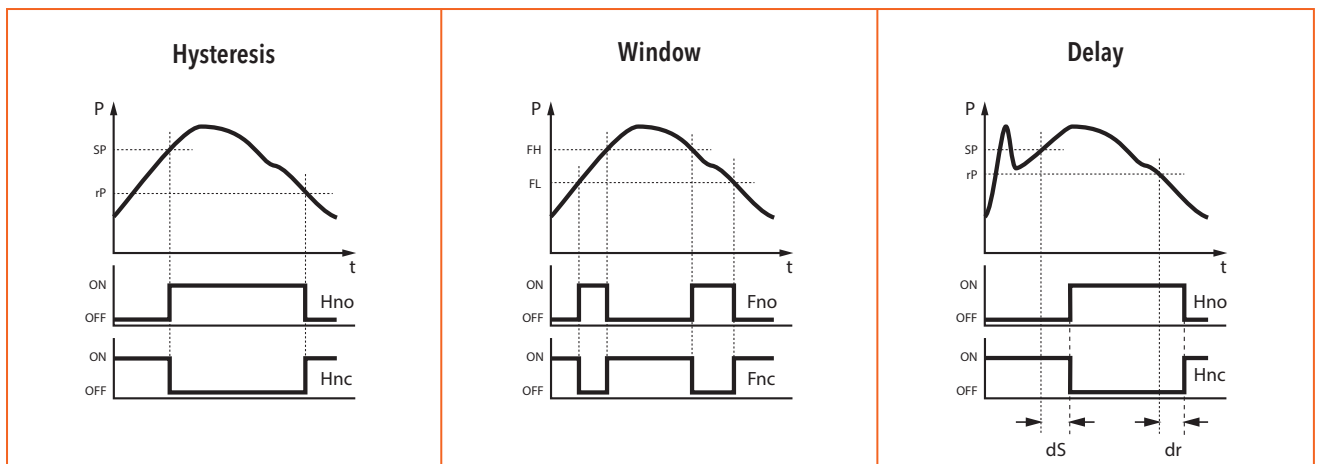

Additional information		
Documents	Data sheet	www.trafag.com/H72320
	Instructions	www.trafag.com/H73320
	Flyer	www.trafag.com/H70691